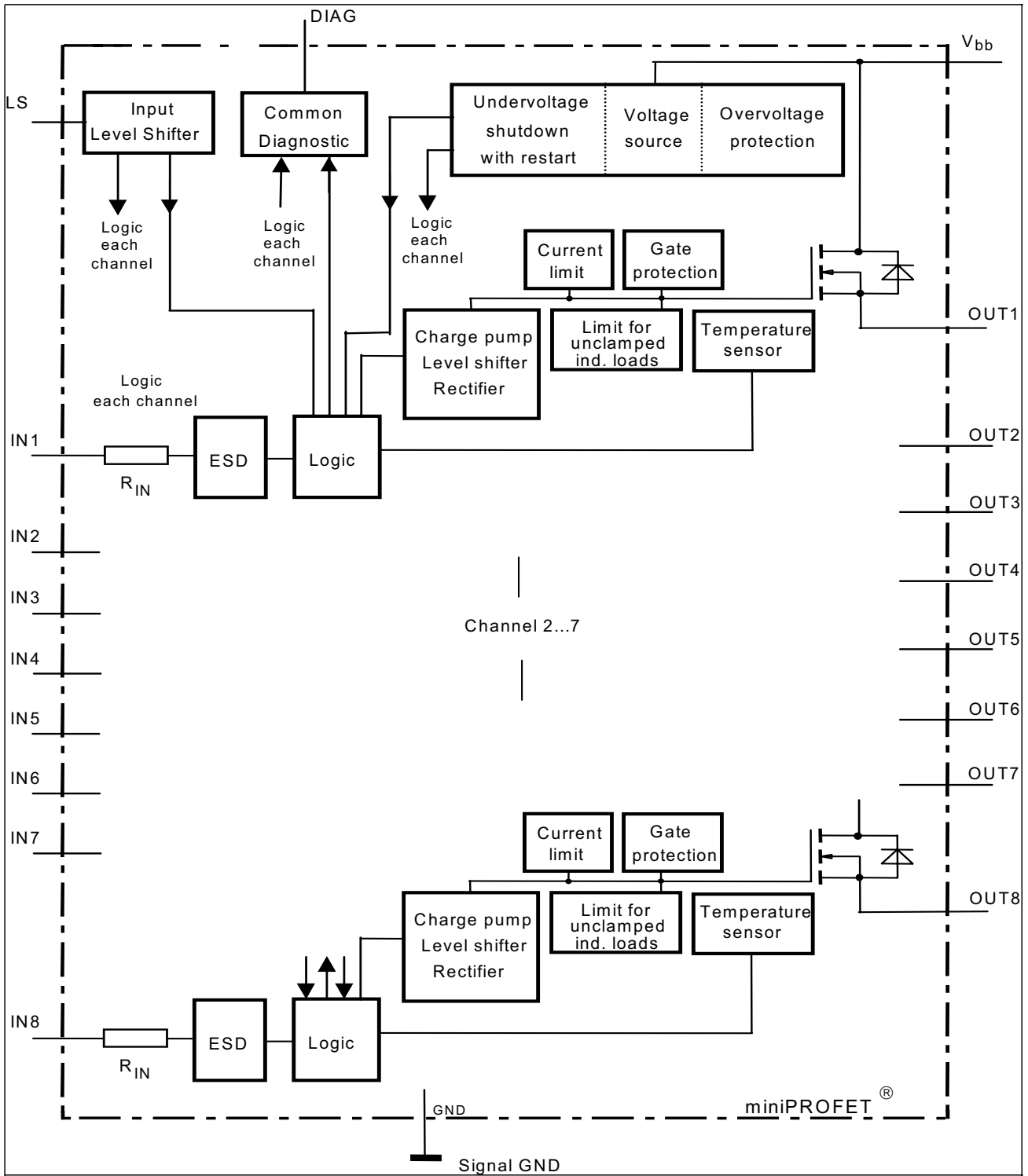




**Smart Power High-Side-Switch  
Eight Channels: 8 x 200 mΩ**

**BTS4880R**

### Block Diagram



<b>Pin</b>	<b>Symbol</b>	<b>Function</b>
1,2,4,5	NC	not connected
3	LS	Enable pin for switching the input-levels to $V_{bb}/2$
6	IN1	Input, activates channel 1 in case of logic high signal
7	IN2	Input, activates channel 2 in case of logic high signal
8	IN3	Input, activates channel 3 in case of logic high signal
9	IN4	Input, activates channel 4 in case of logic high signal
10	IN5	Input, activates channel 5 in case of logic high signal
11	IN6	Input, activates channel 6 in case of logic high signal
12	IN7	Input, activates channel 7 in case of logic high signal
13	IN8	Input, activates channel 8 in case of logic high signal
14-18	NC	not connected
19	GND	Logic ground
20	DIAG	Common diagnostic output for overtemperature
21	OUT8	High-side output of channel 8
22	OUT8	High-side output of channel 8
23	OUT7	High-side output of channel 7
24	OUT7	High-side output of channel 7
25	OUT6	High-side output of channel 6
26	OUT6	High-side output of channel 6
27	OUT5	High-side output of channel 5
28	OUT5	High-side output of channel 5
29	OUT4	High-side output of channel 4
30	OUT4	High-side output of channel 4
31	OUT3	High-side output of channel 3
32	OUT3	High-side output of channel 3
33	OUT2	High-side output of channel 2
34	OUT2	High-side output of channel 2
35	OUT1	High-side output of channel 1
36	OUT1	High-side output of channel 1
TAB	Vbb	Positive power supply voltage

**Maximum Ratings**

Parameter	Symbol	Value	Unit
at $T_j = -40 \dots 135 \text{ }^\circ\text{C}$ , unless otherwise specified			
Supply voltage	$V_{bb}$	-1 <sup>1)</sup> ...45	V
Continuous input voltage <sup>2)</sup>	$V_{IN}$	-10... $V_{bb}$	V
Continuous voltage at LS-pin	$V_{LS}$	-1... $V_{bb}$	
Load current (Short - circuit current, see page 6)	$I_L$	self limited	A
Current through input pin (DC), each channel	$I_{IN}$	$\pm 5$	mA
Reverse current through GND-pin <sup>1)</sup>	$-I_{GND}$	1.6	A
Operating temperature	$T_j$	internal limited	$^\circ\text{C}$
Storage temperature	$T_{stg}$	-55 ... +150	
Power dissipation <sup>3)</sup>	$P_{tot}$	3.3	W
Inductive load switch-off energy dissipation <sup>4)</sup> single pulse, $T_j = 125 \text{ }^\circ\text{C}$ , $I_L = 0.625 \text{ A}$ one channel active all channels simultaneously active ( each channel )	$E_{AS}$		J
			10
			1
Load dump protection <sup>4)</sup> $V_{LoadDump}^{5)} = V_A + V_S$ $V_{IN} = \text{low or high}$ $t_d = 400 \text{ ms}$ , $R_I = 2 \text{ } \Omega$ , $R_L = 27 \text{ } \Omega$ , $V_A = 13.5 \text{ V}$ $t_d = 350 \text{ ms}$ , $R_I = 2 \text{ } \Omega$ , $R_L = 47 \text{ } \Omega$ , $V_A = 27 \text{ V}$	$V_{Loaddump}$		V
			90
			117
<b>Electrostatic discharge voltage</b> (Human Body Model) according to ANSI EOS/ESD - S5.1 - 1993 ESD STM5.1 - 1998 Input pin, LS pin, Common diagnostic pin all other pins	$V_{ESD}$		kV
			$\pm 1$
			$\pm 5$
Continuous reverse drain current <sup>1)4)</sup> , each channel	$I_S$	4	A

<sup>1)</sup> defined by  $P_{tot}$

<sup>2)</sup> At  $V_{IN} > V_{bb}$ , the input current is not allowed to exceed  $\pm 5 \text{ mA}$ .

<sup>3)</sup> Device on 50mm\*50mm\*1.5mm epoxy PCB FR4 with 6 cm<sup>2</sup> (one layer, 70 $\mu\text{m}$  thick) copper area for drain connection. PCB is vertical without blown air.

<sup>4)</sup> not subject to production test, specified by design

<sup>5)</sup>  $V_{Loaddump}$  is setup without the DUT connected to the generator per ISO 7637-1 and DIN 40839 .

Supply voltages higher than  $V_{bb(AZ)}$  require an external current limit for the GND pin, e.g. with a 150 $\Omega$  resistor in GND connection. A resistor for the protection of the input is integrated.

### Electrical Characteristics

Parameter at $T_j = -25...125^\circ\text{C}$ , $V_{bb}=15...30\text{V}$ , unless otherwise specified	Symbol	Values			Unit
		min.	typ.	max.	

### Thermal Characteristics

Thermal resistance junction - case	$R_{thJC}$	-	-	1.5	K/W
Thermal resistance @ min. footprint	$R_{th(JA)}$	-	-	50	
Thermal resistance @ 6 cm <sup>2</sup> cooling area <sup>1)</sup>	$R_{th(JA)}$	-	-	38	

### Load Switching Capabilities and Characteristics

On-state resistance $T_j = 25^\circ\text{C}$ , $I_L = 0.5\text{ A}$ $T_j = 125^\circ\text{C}$	$R_{ON}$	-	150	200	m $\Omega$
		-	270	320	
Turn-on time to 90% $V_{OUT}$ $R_L = 47\ \Omega$ , $V_{IN} = 0$ to 10 V	$t_{on}$	-	50	100	$\mu\text{s}$
Turn-off time to 10% $V_{OUT}$ $R_L = 47\ \Omega$ , $V_{IN} = 10$ to 0 V	$t_{off}$	-	75	150	
Slew rate on 10 to 30% $V_{OUT}$ , $R_L = 47\ \Omega$ , $V_{bb} = 15\text{ V}$	$dV/dt_{on}$	-	1	2	V/ $\mu\text{s}$
Slew rate off 70 to 40% $V_{OUT}$ , $R_L = 47\ \Omega$ , $V_{bb} = 15\text{ V}$	$-dV/dt_{off}$	-	1	2	

<sup>1</sup> Device on 50mm\*50mm\*1.5mm epoxy PCB FR4 with 6 cm<sup>2</sup> (one layer, 70 $\mu\text{m}$  thick) copper area for drain connection. PCB is vertical without blown air.

## Electrical Characteristics

Parameter at $T_j = -25...125^\circ\text{C}$ , $V_{bb}=15...30\text{V}$ , unless otherwise specified	Symbol	Values			Unit
		min.	typ.	max.	
<b>Operating Parameters</b>					
Operating voltage	$V_{bb(\text{on})}$	11	-	45	V
Undervoltage shutdown	$V_{bb(\text{under})}$	7	-	10.5	
Undervoltage restart	$V_{bb(\text{u rst})}$	-	-	11	
Undervoltage hysteresis $\Delta V_{bb(\text{under})} = V_{bb(\text{u rst})} - V_{bb(\text{under})}$	$\Delta V_{bb(\text{under})}$	-	0.5	-	
Standby current	$I_{bb(\text{off})}$	-	50	150	$\mu\text{A}$
Operating current <sup>1)</sup>	$I_{\text{GND}}$	-	5	12	mA
Leakage output current (included in $I_{bb(\text{off})}$ ) $V_{\text{IN}} = \text{low}$ , each channel	$I_{\text{L}(\text{off})}$	-	5	10	$\mu\text{A}$

## Protection Functions<sup>2)</sup>

Initial peak short circuit current limit $T_j = -25^\circ\text{C}$ , $V_{bb} = 30\text{V}$ , $t_m = 700\ \mu\text{s}$ $T_j = 25^\circ\text{C}$ $T_j = 125^\circ\text{C}$	$I_{\text{L}(\text{SCp})}$	- - 0.7	- 1.4 -	1.9 - -	A
Repetitive short circuit current limit $T_j = T_{jt}$ (see timing diagrams)	$I_{\text{L}(\text{SCR})}$	-	1.1	-	
Output clamp (inductive load switch off) at $V_{\text{OUT}} = V_{bb} - V_{\text{ON}(\text{CL})}$ ,	$V_{\text{ON}(\text{CL})}$	47	53	60	V
Overvoltage protection <sup>3)</sup>	$V_{bb(\text{AZ})}$	47	-	-	
Thermal overload trip temperature <sup>4)</sup>	$T_{jt}$	135	-	-	$^\circ\text{C}$
Thermal hysteresis	$\Delta T_{jt}$	-	10	-	K

<sup>1)</sup>contains all input currents

<sup>2)</sup>Integrated protection functions are designed to prevent IC destruction under fault conditions described in the data sheet. Fault conditions are considered as "outside" normal operating range. Protection functions are not designed for continuous repetitive operation.

<sup>3)</sup> see also  $V_{\text{ON}(\text{CL})}$  in circuit diagram on page 10

<sup>4)</sup> higher operating temperature at normal function for each channel available

**Electrical Characteristics**

Parameter at $T_j = -25...125^\circ\text{C}$ , $V_{bb}=15...30\text{V}$ , unless otherwise specified	Symbol	Values			Unit
		min.	typ.	max.	
<b>Input</b>					
Continuous input voltage <sup>1)</sup>	$V_{IN}$	-10	-	$V_{bb}$	V
Input turn-on threshold voltage CMOS <sup>2)</sup>	$V_{IN(T+)}$	-	-	2.2	
Input turn-off threshold voltage CMOS <sup>2)</sup>	$V_{IN(T-)}$	0.8	-	-	
Input turn-on threshold voltage $V_{bb}/2$ <sup>2)</sup>	$V_{IN(T+)}$	-	-	$V_{bb}/2+1$	
Input turn-off threshold voltage $V_{bb}/2$ <sup>2)</sup>	$V_{IN(T-)}$	$V_{bb}/2-1$	-	-	
Input threshold hysteresis	$\Delta V_{IN(T)}$	-	0.3	-	
Off state input current CMOS ( each channel )	$I_{IN(off)}$	8	-	-	$\mu\text{A}$
On state input current CMOS ( each channel )	$I_{IN(on)}$	-	-	70	
Off state input current $V_{bb}/2$ ( each channel )	$I_{IN(off)}$	80	-	-	
On state input current $V_{bb}/2$ ( each channel )	$I_{IN(on)}$	-	-	260	
Input delay time at switch on $V_{bb}$	$t_d(V_{bbon})$	150	340	-	$\mu\text{s}$
Input resistance (see page 10)	$R_I$	2	3	4	$\text{k}\Omega$
Internal pull down resistor at LS-pin <sup>3)</sup>	$R_{LS}$	300	800	-	

**Diagnostic Characteristics**

Common diagnostic output current <sup>4)</sup> ( overtemperature of any channel ) $T_j = 135^\circ\text{C}$	$I_{diag}$	2	3	4	$\text{mA}$
Common diagnostic output leakage current	$I_{diag(high)}$	-	-	2	$\mu\text{A}$

<sup>1)</sup>At  $V_{IN} > V_{bb}$ , the input current is not allowed to exceed  $\pm 5\text{ mA}$ .

<sup>2)</sup>see page 9

<sup>3)</sup>LS-pin is connected to  $V_{bb}$

<sup>4)</sup>see page 10

**Electrical Characteristics**

Parameter at $T_j = -25...125^\circ\text{C}$ , $V_{bb}=15...30\text{V}$ , unless otherwise specified	Symbol	Values			Unit
		min.	typ.	max.	
<b>Reverse Battery</b>					
Reverse battery voltage <sup>1)</sup> $R_{GND} = 0 \Omega$ $R_{GND} = 150 \Omega$	$-V_{bb}$	-	-	1 45	V
Diode forward on voltage $I_F = 1.25 \text{ A}$ , $V_{IN} = \text{low}$ , each channel	$-V_{ON}$	-	-	1.2	

<sup>1</sup>defined by  $P_{tot}$



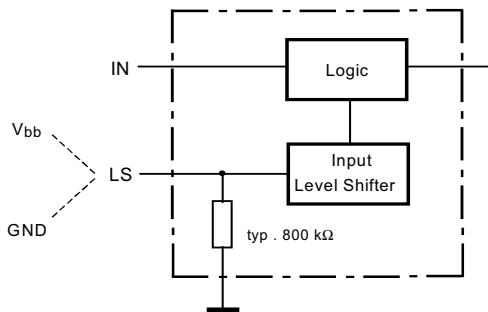
**Truth table for common diagnostic pin ( LED-driver ):**

	Input level	Output level	Diagnostic
Normal operation	L	L	L
	H	H	L
Short circuit to GND	L	L	L
	H	L	L
Undervoltage	L	L	L
	H	L	L
Overtemperature	L	L	L
	H	L	H <sup>1)</sup>

L = no diagnostic output current

H = diagnostic output current typ. 2 mA (see page 7)

**Programmable input:**



**Functional description LS-Pin:**

With using the LS-pin it is possible to change the input turn-on and -off threshold voltage between CMOS and half supply voltage level.

Therefore you have either to connect the LS-pin to GND ( state 1 ) or to supply voltage ( state 2 )

If the LS-pin is not connected the input threshold voltages are automatically at CMOS level, caused by an internal pull down to GND with typ. 800kΩ ( see circuit ).

State 1: LS-Pin to GND

CMOS - Input level

State 2: LS-Pin to supply voltage

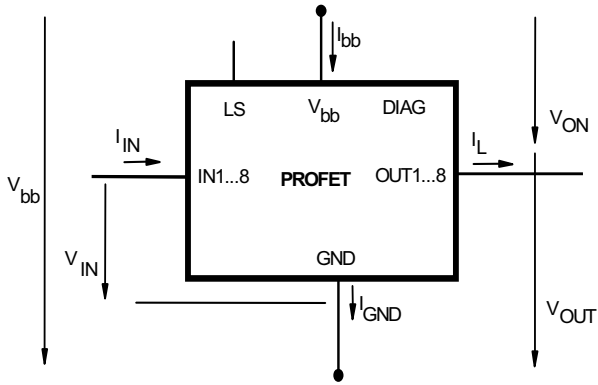
$V_{bb}/2$  - Input level

<sup>1</sup>toggeling with restart

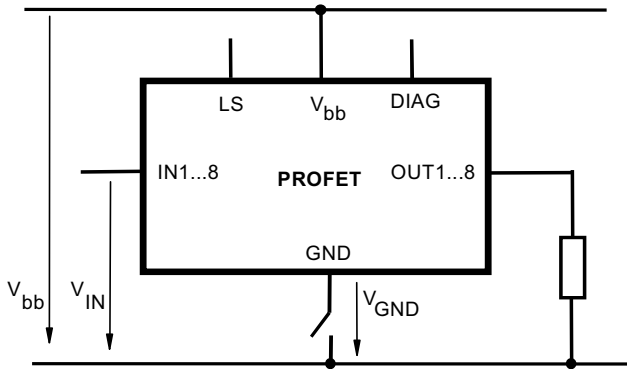
**Terms**  
each channel

DC UUK/(1N

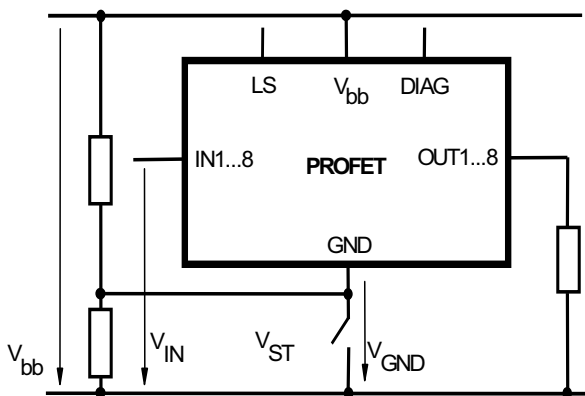
**Inductive and overvoltage output clamp**  
each channel



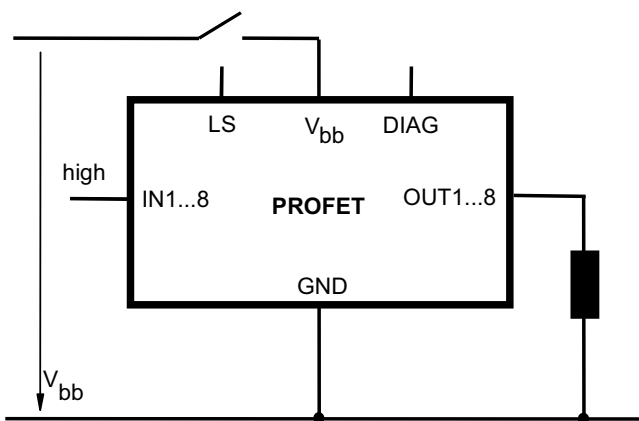
**GND disconnect**



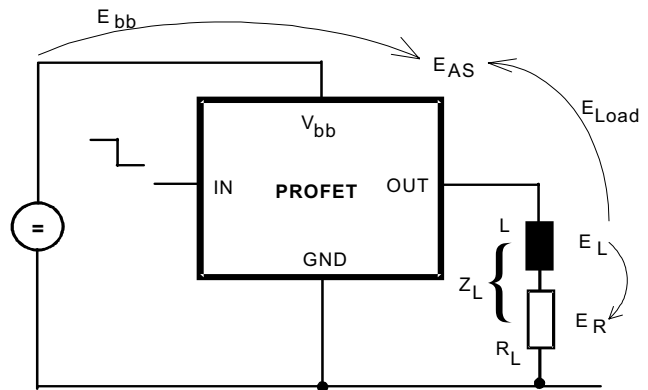
**GND disconnect with GND pull up**



**V<sub>bb</sub> disconnect with charged inductive load**



**Inductive Load switch-off energy dissipation, each channel**



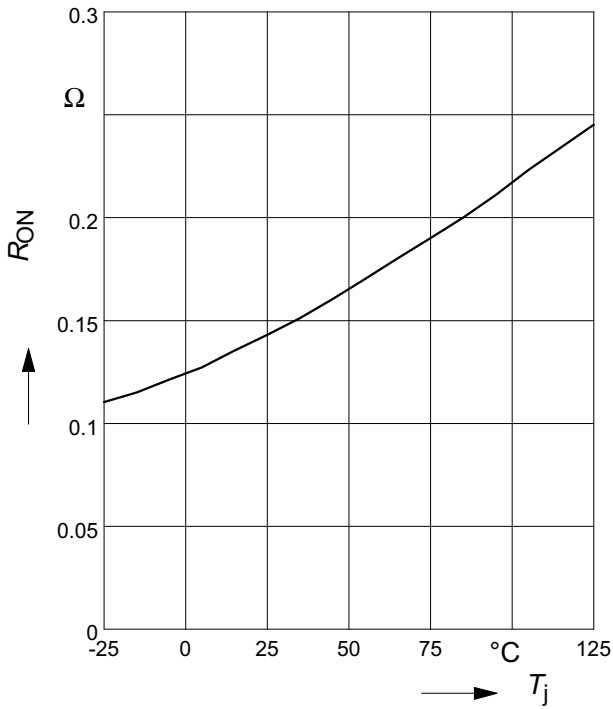
Energy stored in load inductance:  $E_L = \frac{1}{2} * L * I_L^2$

While demagnetizing load inductance, the energy dissipated in PROFET is  $E_{AS} = E_{bb} + E_L - E_R = V_{ON(CL)} * i_L(t) dt$ , with an approximate solution for  $R_L > 0\Omega$ :

$$E_{AS} = \frac{I_L * L}{2 * R_L} * (V_{bb} + |V_{OUT(CL)}|) * \ln\left(1 + \frac{I_L * R_L}{|V_{OUT(CL)}|}\right)$$

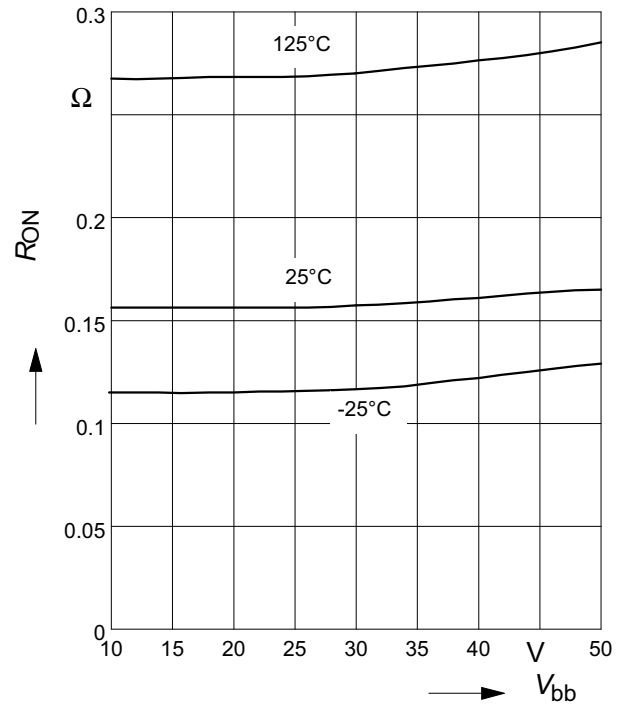
**Typ. on-state resistance**

$R_{ON} = f(T_j)$ ;  $V_{bb} = 15V$ ;  $V_{in} = \text{high}$



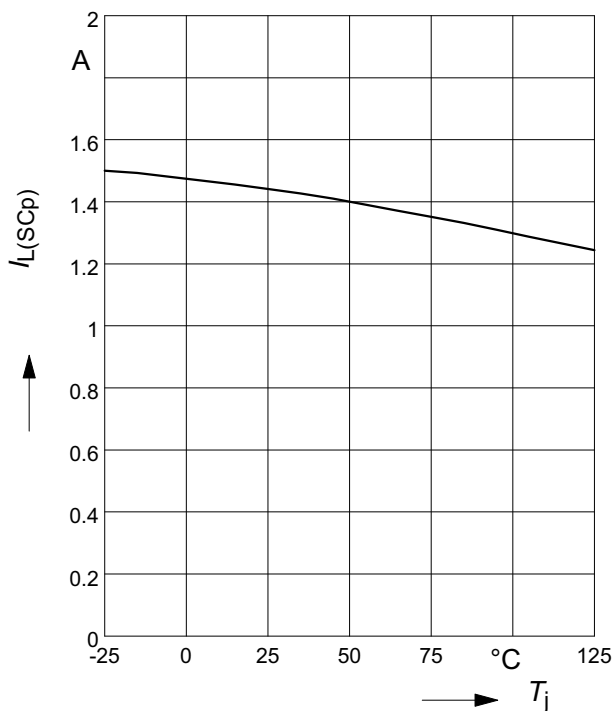
**Typ. on-state resistance**

$R_{ON} = f(V_{bb})$ ;  $I_L = 0.5A$ ;  $V_{in} = \text{high}$



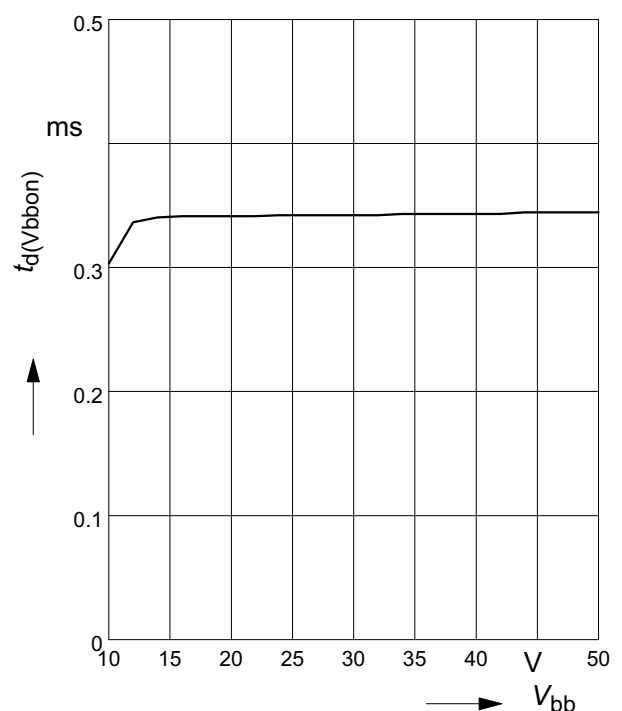
**Typ. initial peak short circuit current limit**

$I_{L(SCP)} = f(T_j)$ ;  $V_{bb} = 24V$



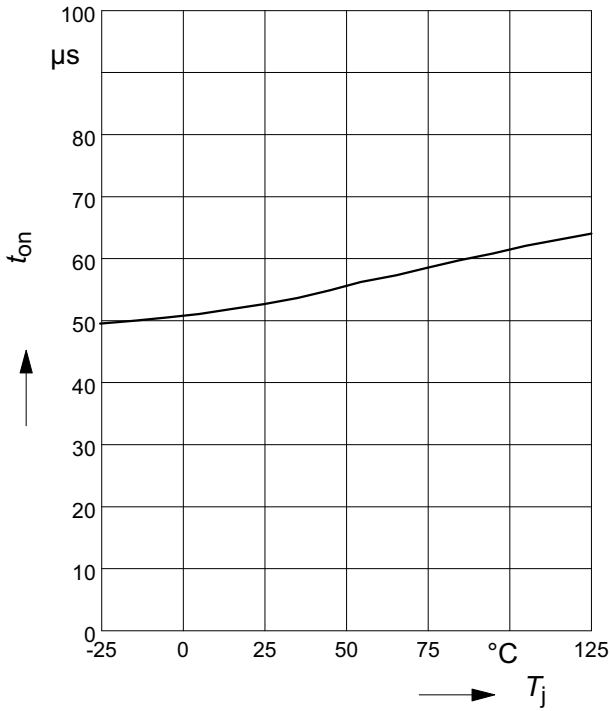
**Typ. input delay time at switch on  $V_{bb}$**

$t_d(V_{bbon}) = f(V_{bb})$ ;  $T_j = -25...125^{\circ}C$



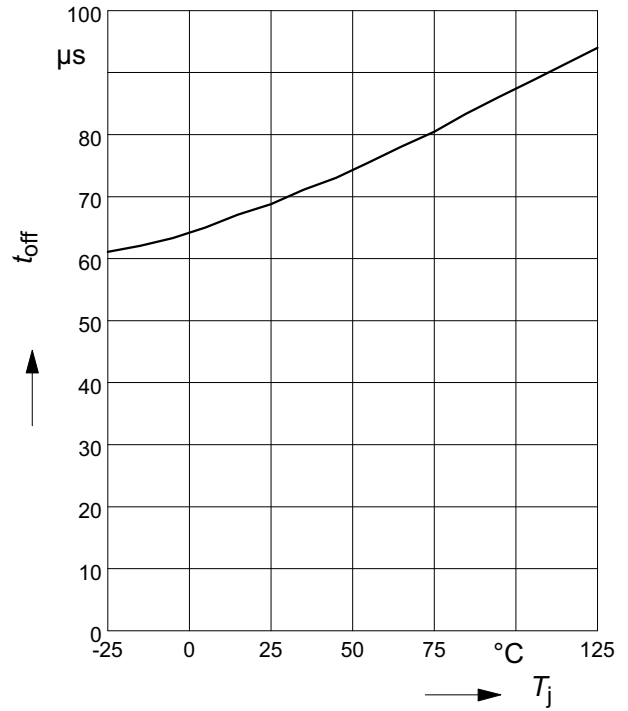
**Typ. turn on time**

$t_{on} = f(T_j); R_L = 47\Omega$



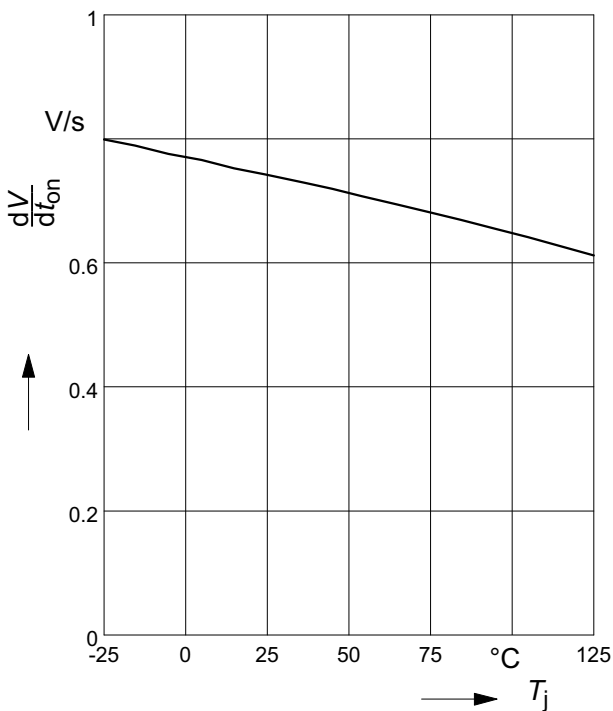
**Typ. turn off time**

$t_{off} = f(T_j); R_L = 47\Omega$



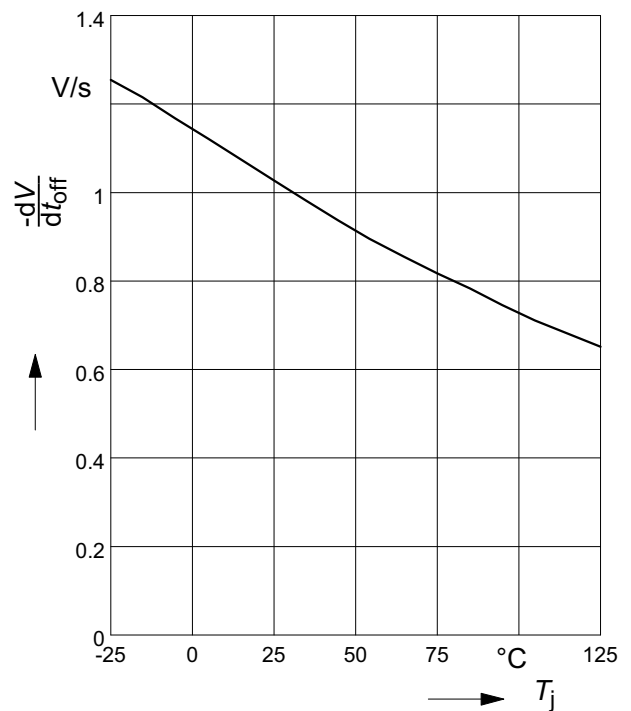
**Typ. slew rate on**

$dV/dt_{on} = f(T_j); R_L = 47\Omega, V_{bb} = 15V$



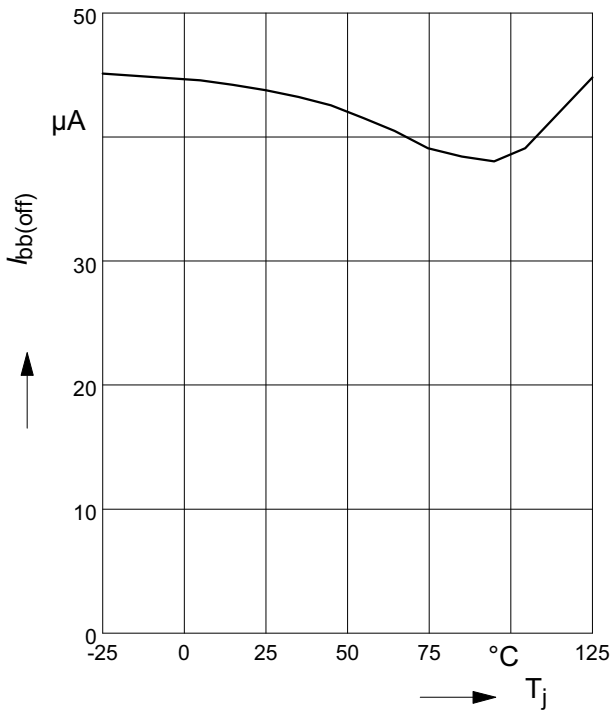
**Typ. slew rate off**

$-dV/dt_{off} = f(T_j); R_L = 47\Omega, V_{bb} = 15V$



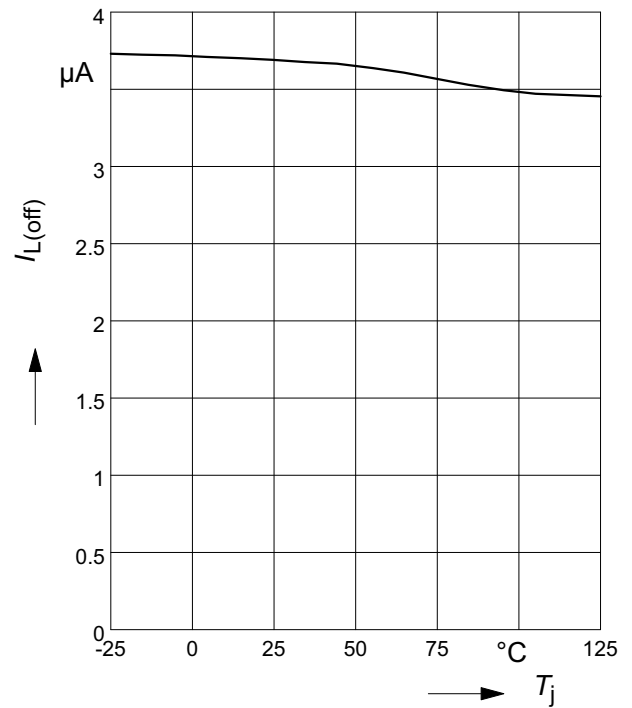
**Typ. standby current**

$I_{bb(off)} = f(T_j)$  ;  $V_{bb} = 30V$  ;  $V_{IN} = low$



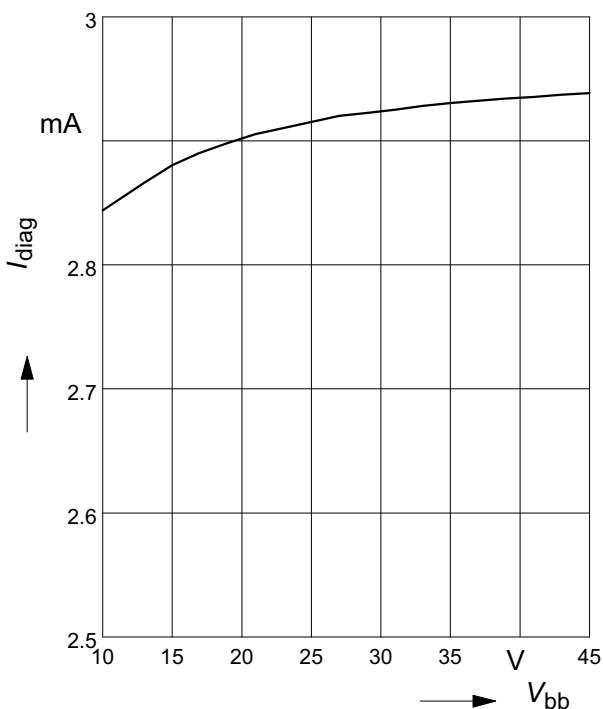
**Typ. leakage current**

$I_{L(off)} = f(T_j)$  ;  $V_{bb} = 30V$  ;  $V_{IN} = low$



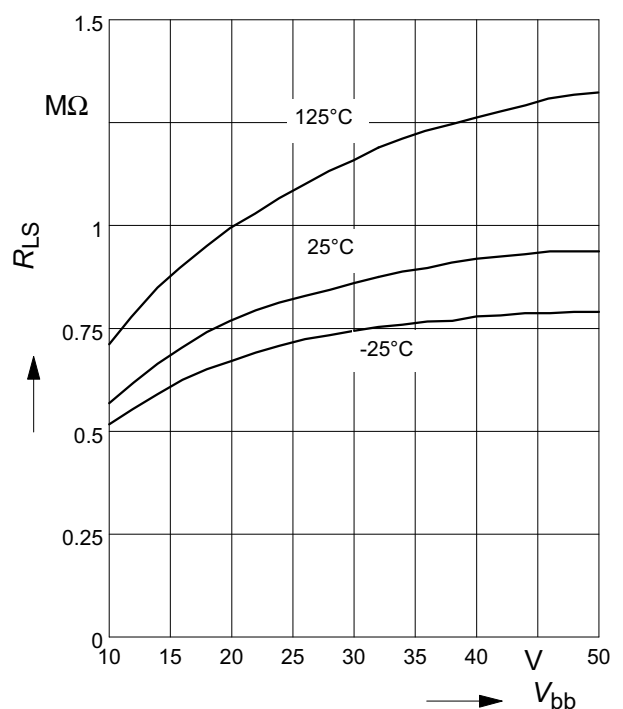
**Typ. common diagnostic output current**

$I_{diag} = f(V_{bb})$  ;  $T_j = 135°C$



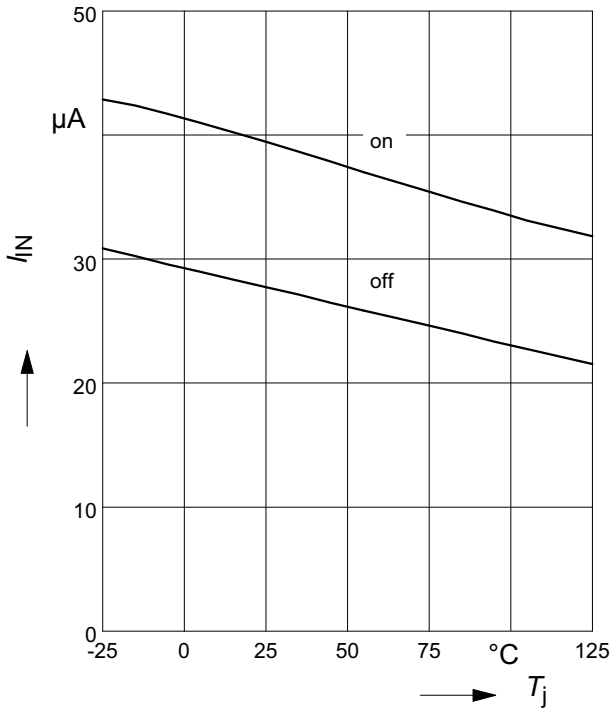
**Typ. internal pull down resistor at LS-pin**

$R_{LS} = f(V_{bb})$  ;  $V_{LS} = V_{bb}$



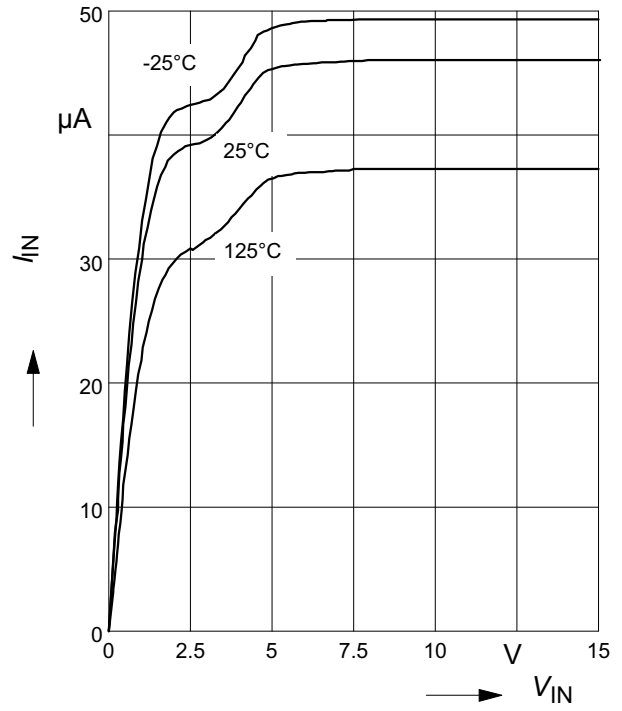
**Typ. input current @ CMOS level**

$I_{IN(on/off)} = f(T_j)$ ;  $V_{bb} = 15V$ ;  $V_{IN} = \text{low/high}$   
 $V_{INlow} \leq 0,8V$ ;  $V_{INhigh} = 2,2V$



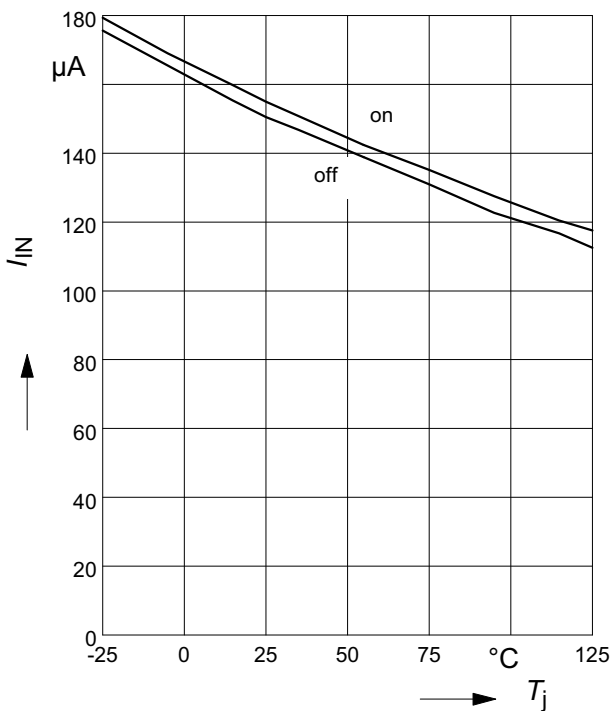
**Typ. input current @ CMOS level**

$I_{IN} = f(V_{IN})$ ;  $V_{bb} = 15V$



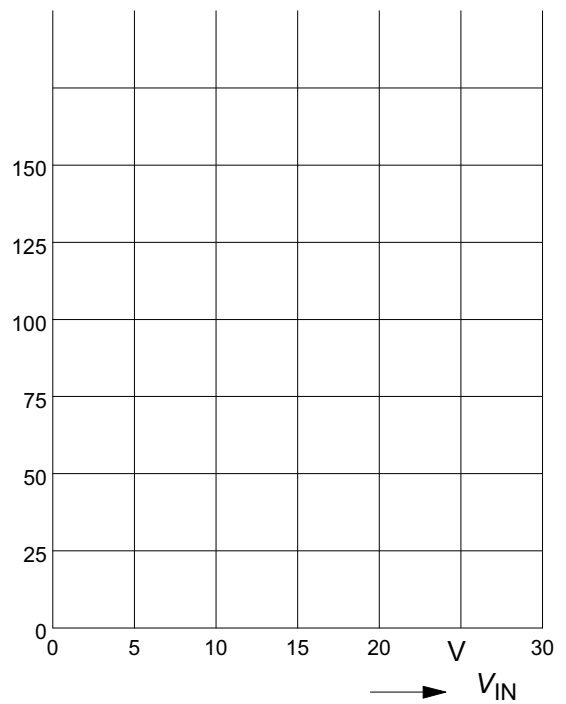
**Typ. input current @ V<sub>bb</sub>/2 level**

$I_{IN(on/off)} = f(T_j)$ ;  $V_{bb} = 30V$ ;  $V_{IN} = \text{low/high}$



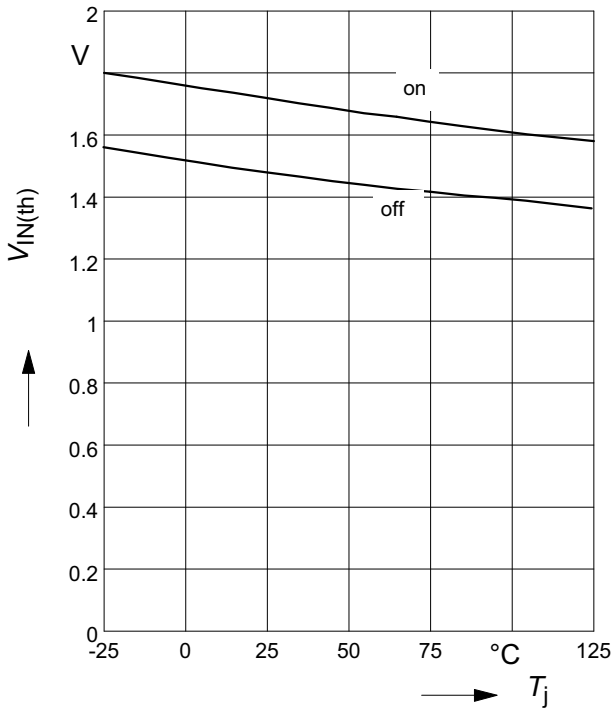
**Typ. input current @ V<sub>bb</sub>/2 level**

$I_{IN} = f(V_{IN})$ ;  $V_{bb} = 30V$



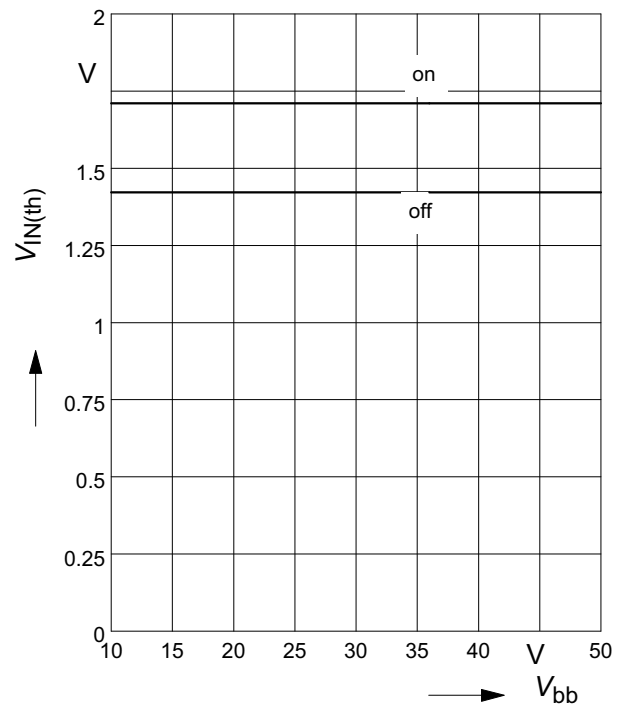
**Typ. input threshold voltage  
@ CMOS level**

$V_{IN(th)} = f(T_j) ; V_{bb} = 15V$



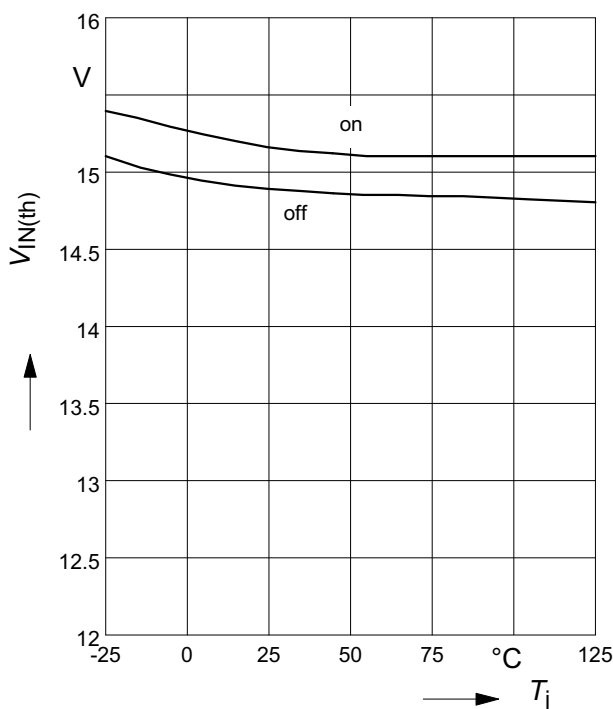
**Typ. input threshold voltage  
@ CMOS level**

$V_{IN(th)} = f(V_{bb}) ; T_j = 25^{\circ}C$



**Typ. input threshold voltage  
@ V<sub>bb</sub>/2 level**

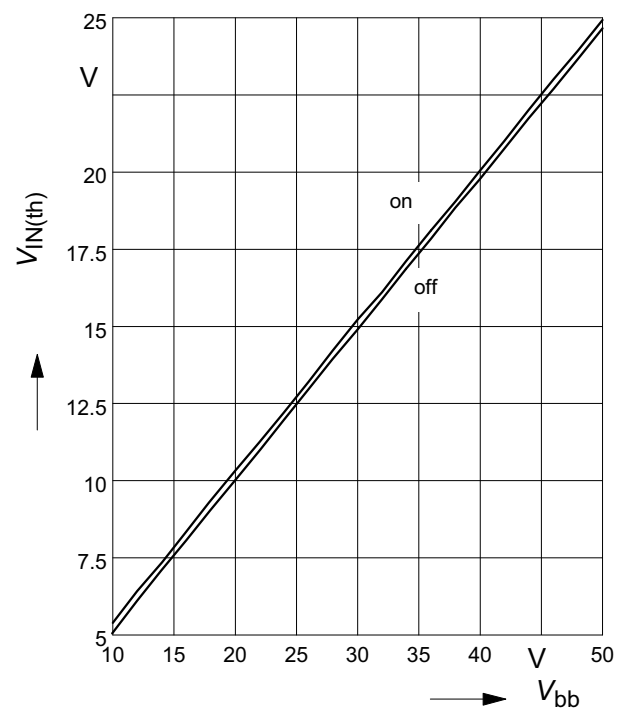
$V_{IN(th)} = f(T_j) ; V_{bb} = 30V$



**Typ. input threshold voltage**

**@ V<sub>bb</sub>/2 level: LS-pin connected to V<sub>bb</sub>**

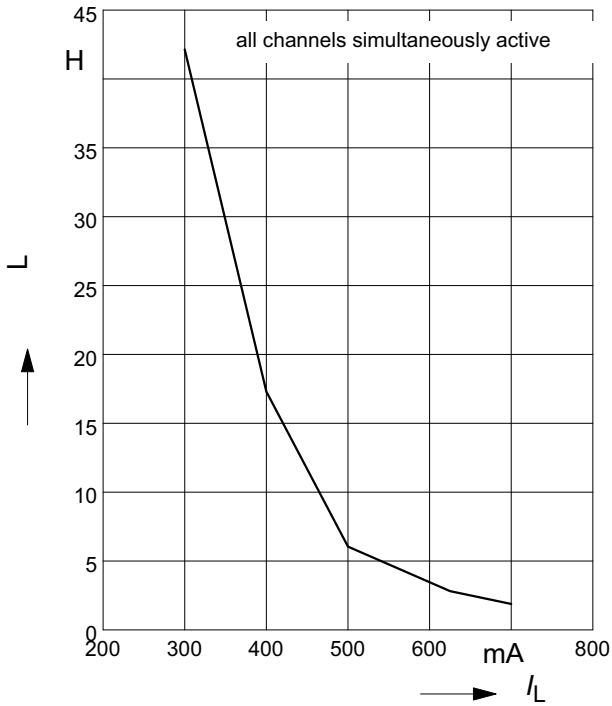
$V_{IN(th)} = f(V_{bb}) ; T_j = 25^{\circ}C$





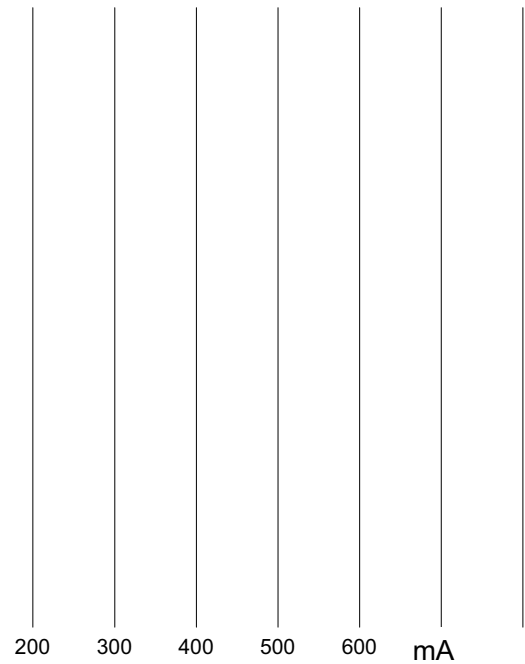
**Maximum allowable load inductance for a single switch off, calculated**

$L = f(I_L); T_{jstart}=125^{\circ}\text{C}, V_{bb}=24\text{V}, R_L=0\Omega$



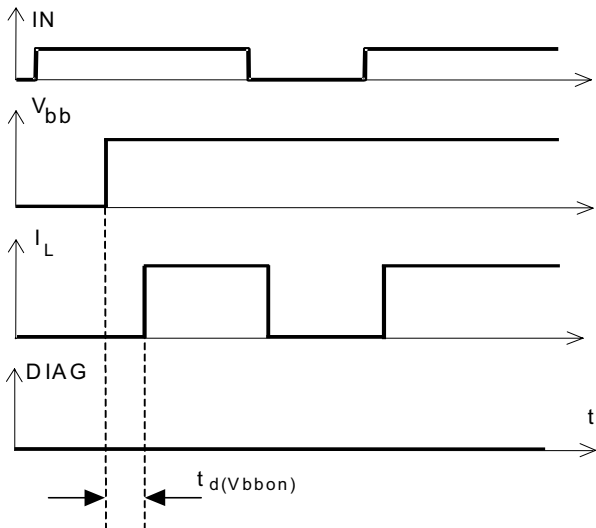
**Maximum allowable inductive switch-off energy, single pulse**

$E_{AS} = f(I_L); T_{jstart} = 125^{\circ}\text{C}, V_{bb} = 24\text{V}$

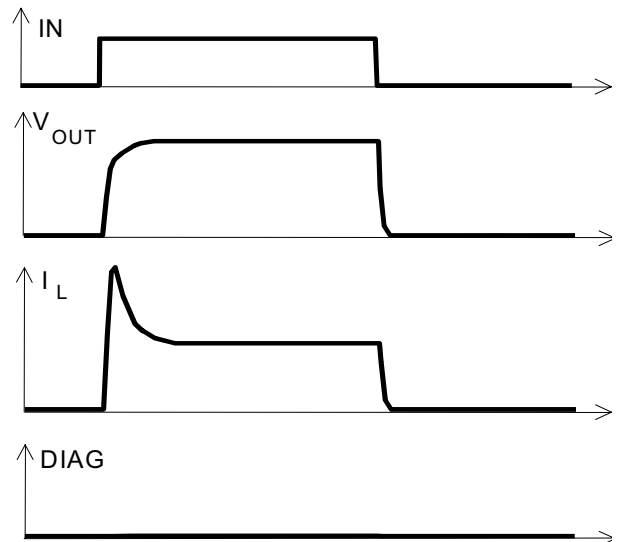


## Timing diagrams

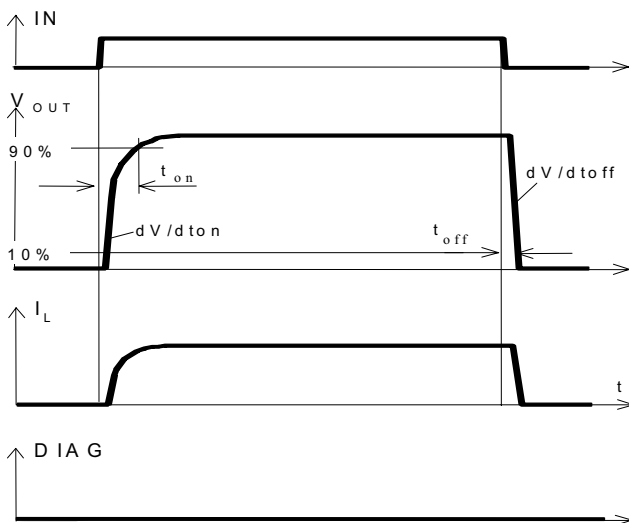
**Figure 1a: V<sub>bb</sub> turn on:**



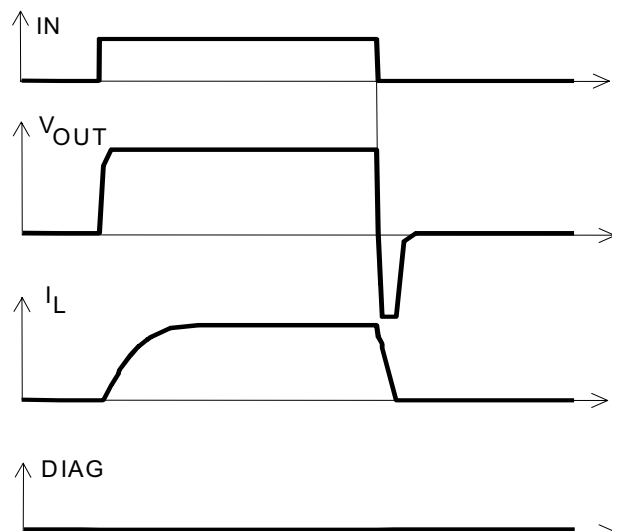
**Figure 2b: Switching a lamp**



**Figure 2a: Switching a resistive load, turn-on/off time and slew rate definition**

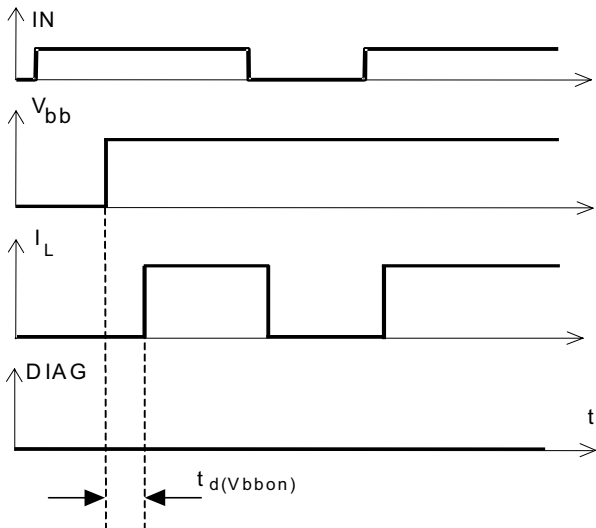


**Figure 2c: Switching an inductive load**

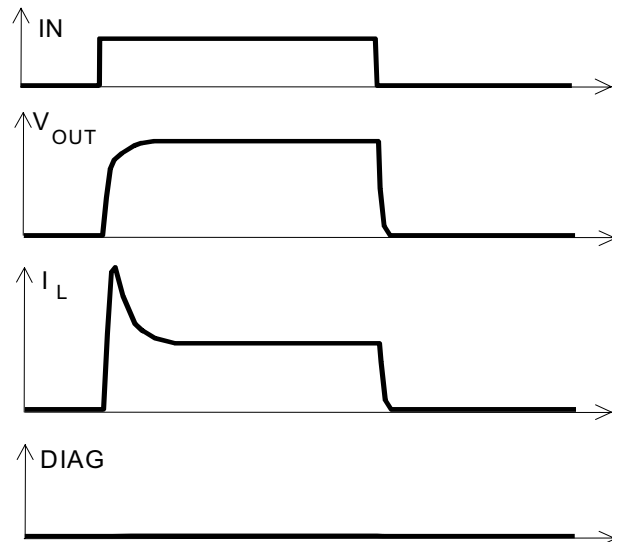


## Timing diagrams

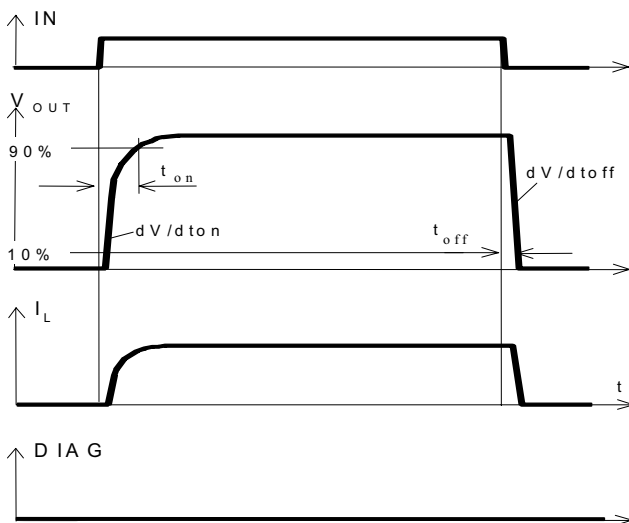
**Figure 1a: Vbb turn on:**



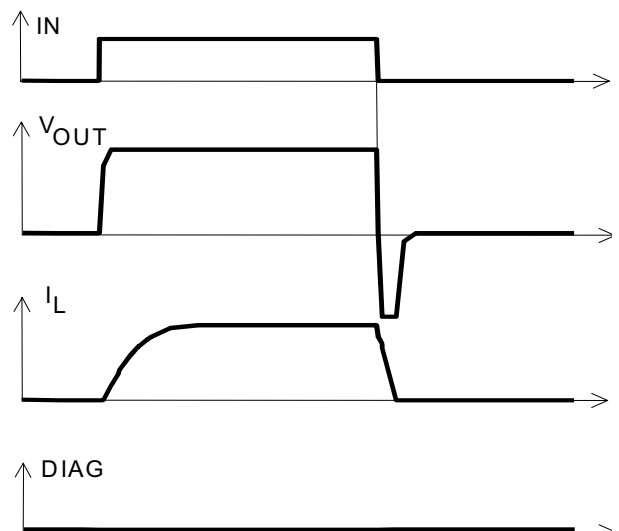
**Figure 2b: Switching a lamp**



**Figure 2a: Switching a resistive load, turn-on/off time and slew rate definition**



**Figure 2c: Switching an inductive load**





### Package Outlines

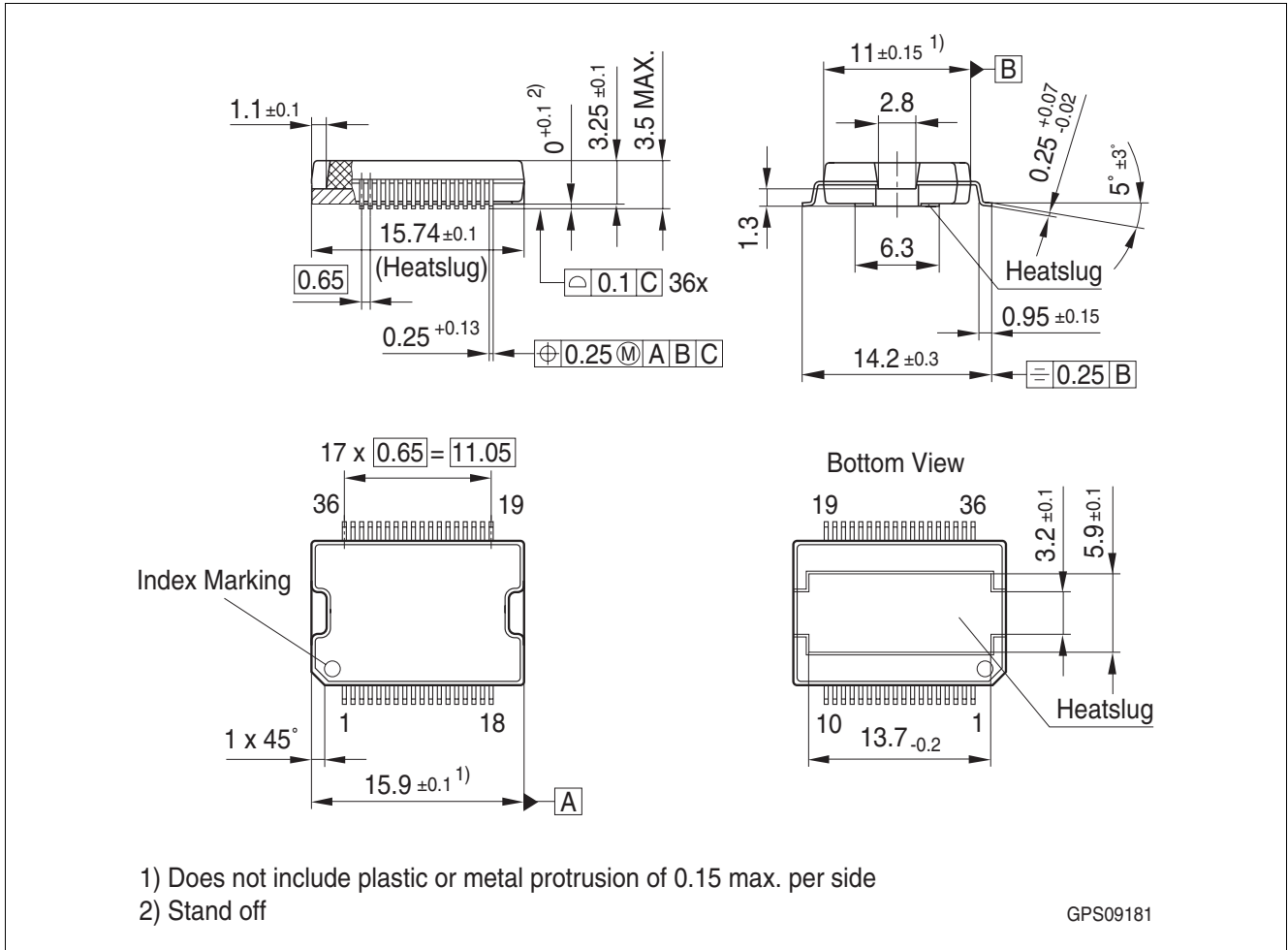


figure 6: PG-DSO-36

### Green Product (RoHS compliant)

To meet the world-wide customer requirements for environmentally friendly products and to be compliant with government regulations the device is available as a green product. Green products are RoHS-Compliant (i.e. Pb-free finish on leads and suitable for Pb-free soldering according to IPC/JEDEC J-STD-020).

For further information on alternative packages, please visit our website:  
<http://www.infineon.com/packages>.

Dimensions in mm

## Revision History

Revision	Date	Changes
1.1	2007-10-18	RoHS-compliant DSO package version of the BTS4880R. All pages: Infineon logo updated Page 1: Added "AEC qualified" and "RoHS" logo, added "Green Product (RoHS compliant)" and "AEC qualified" statement to feature list, package names changed to RoHS compliant versions. Page 21: Package names changed to RoHS compliant versions, added "Green Product" description added Revision History added Legal Disclaimer Package name changed to PG-DSO-36

**Edition 2007-10-18**

**Published by  
Infineon Technologies AG  
81726 Munich, Germany**

**© 2007 Infineon Technologies AG  
All Rights Reserved.**

### **Legal Disclaimer**

The information given in this document shall in no event be regarded as a guarantee of conditions or characteristics. With respect to any examples or hints given herein, any typical values stated herein and/or any information regarding the application of the device, Infineon Technologies hereby disclaims any and all warranties and liabilities of any kind, including without limitation, warranties of non-infringement of intellectual property rights of any third party.

### **Information**

For further information on technology, delivery terms and conditions and prices, please contact the nearest Infineon Technologies Office ([www.infineon.com](http://www.infineon.com)).

### **Warnings**

Due to technical requirements, components may contain dangerous substances. For information on the types in question, please contact the nearest Infineon Technologies Office.

Infineon Technologies components may be used in life-support devices or systems only with the express written approval of Infineon Technologies, if a failure of such components can reasonably be expected to cause the failure of that life-support device or system or to affect the safety or effectiveness of that device or system. Life support devices or systems are intended to be implanted in the human body or to support and/or maintain and sustain and/or protect human life. If they fail, it is reasonable to assume that the health of the user or other persons may be endangered.